

SynQor[®]

MPPS MILITARY FIELD-GRADE

MPPS-4000-270

Military-Grade 3 Φ AC to DC Power Supply

3-Phase 360-528 Vrms L-L 47-65 Hz Input	25-400 V Programmable 4000 W DC Output	Surge-Rated for 4500 W Transient (15 s)	90% Full Load Efficiency
---	--	---	---

Sealed Construction, Ultra Low Weight, Compact Size



DESIGNED & MANUFACTURED IN USA

N+M REDUNDANCY

SynQor's Military Field-Grade Programmable Power Supply units are designed for the extreme environmental and demanding electrical conditions of Military/Aerospace applications. SynQor's MPPS-4000-270 incorporates field proven high efficiency designs and rugged packaging technologies. This MPPS will accept a 3-Phase AC input and change it to a tightly regulated high voltage DC output using a two-stage DC link isolated topology. The output is programmable by the user from 25-400 V. Full output power is available from 175-400 V. The output current limit is also programmable by the user for battery charging applications. The MPPS-4000-270 is designed to comply with a wide range of military standards. Parallel up to 32 units for increased power, and/or N+M redundancy.

Combine Units for Higher Power and/or Redundancy

Features

- Sealed, weather-proof, shock-proof construction
- Two-stage, DC link isolated topology
- Programmable output voltage 25 - 400 V
- Full Power available from 175 - 400 V
- Programmable current limit 0.2 - 24 A
- Tightly regulated, low noise DC output
- 4000 W continuous output power; 15 s transient to 4500 W
- Appropriate for pulsed loads, high capacitance loads, battery charging
- Full power operation: -40 °C to +55 °C
- 3-Phase 360-528 Vrms L-L Δ input (draws balanced currents)
- 47-65 Hz input frequency range
- Up to 32 units can be combined for higher power, and/or N+M redundancy
- User I/O and Configuration signal ports
- Battle Mode for over-temperature events
- 1U high rack mount unit (17.00"W x 22.42"D x 1.73"H)

Specification Compliance

MPPS-270 units are designed to meet:

- MIL-STD-1399-300B - Interface Std for Shipboard Systems
- MIL-STD-810G - Environmental Engineering Considerations
- MIL-STD-461F - Electromagnetic Interface

In-Line Manufacturing Process

- AS9100 and ISO 9001 certified facility
- Full component traceability

Contents

Technical Specification	2
Block Diagram	4
Mechanical Features	5
Accessory Options	7
Ordering Information	8



SynQor[®]

Technical Specification

MPPS MILITARY FIELD-GRADE

MPPS-4000-270

AC INPUT OPERATING CHARACTERISTICS

Voltage	3-Phase, 360-528 Vrms L-L
Frequency	47-65 Hz
Input Current Total Harmonic Distortion	<3% (4000 W load)
Input Power Factor (Distortion Component)	>0.99 (4000 W load)
Input Current Balance (Highest - Lowest)	<2%
Max. Input Current Per Phase @ 360 Vrms L-L	8.5 Arms (4500 W load)
Integrated AC Input Circuit Breaker Rating	12 Arms

DC OUTPUT CHARACTERISTICS

Continuous Output Power	4000 W
Transient Output Power (15 seconds)	4500 W
Voltage Range	25 - 400 V
Voltage Setpoint (Default)	270 V
Voltage Setpoint Accuracy	± 3%
Voltage Setpoint Resolution	1 V
Voltage Regulation (Over Load & Temperature)	± 5%
Current Limit Range (User Adjustable)	0.2 - 24 A
Current Limit Resolution	0.2 A
Short Circuit Protection Trip Current	80 A
Maximum Output Capacitance	18 mF

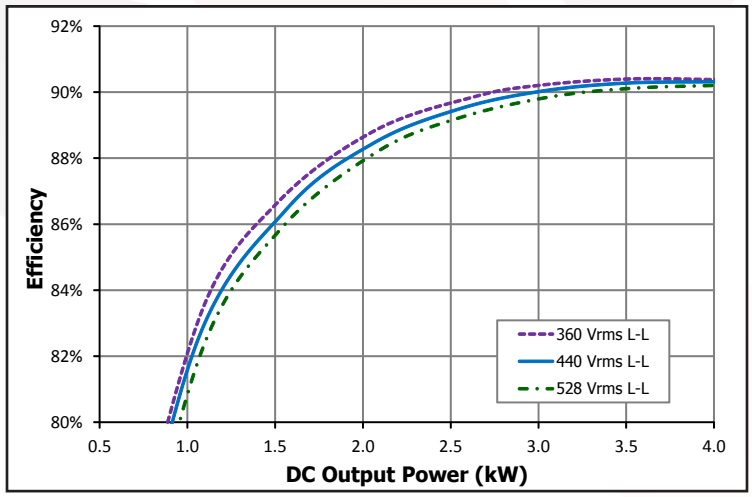
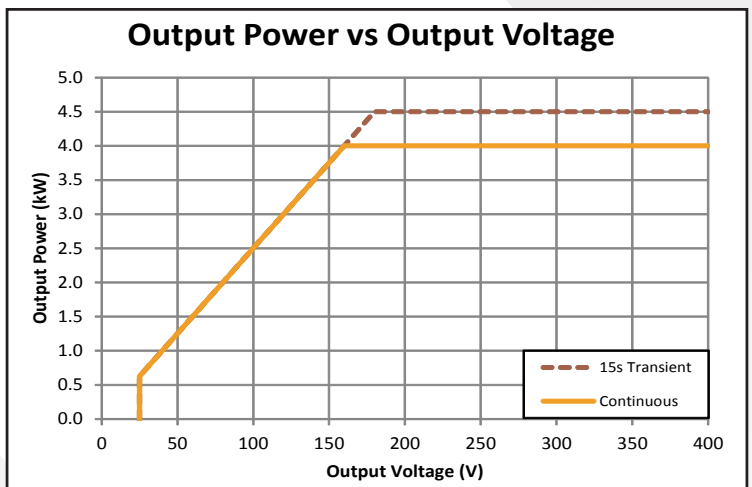

ENVIRONMENTAL CHARACTERISTICS MIL-STD-810G

Temperature Methods 501.5, 502.5	
Operating Ambient Temperature	
Full Rated Power	-40 °C to +55 °C
Reduced Power	+55 °C to +70 °C
Storage Temperature	-40 °C to +70 °C
Altitude Method 500.5	
Operating	0 - 18,000 ft
Non-operating	0 - 40,000 ft
Environmental Tests	
Shock/Drop	Method 516.6, Procedures 1, 4, 6
Temperature Shock	Method 503.5, Procedure 1
Vibration	Method 514.6, CAT 5, 7, 8, 9, 24
Fungus	Method 508.6
Salt Fog	Method 509.5
Sand and Dust	Method 510.5, Procedures 1, 2
Rain	Method 506.5 Procedure 1
Humidity	Method 507.5 Procedure 2
Mechanical Vibrations of Shipboard Equipment	Method 528 Procedure 1

RELIABILITY CHARACTERISTICS MIL-HDBK-217F

MTBF: 450 kHrs MIL-217F Ground Benign, Ta=25 °C

INTERFACE STD FOR SHIPBOARD SYSTEMS MIL-STD-1399B

Type I 440 V 3-Phase Input Power

ELECTROMAGNETIC CAPABILITY MIL-STD-461F

CE101-2	30 Hz - 10 kHz
CE102	10 kHz - 10 MHz
CS101	30 Hz - 150 kHz
CS106	Pulse Transients
CS114 (Curve #5)	10 kHz - 200 MHz
CS115	Impulse Excitation
CS116	10 kHz - 100 MHz
RE101 (Navy Limit)	30 Hz - 100 kHz
RE102 (Navy Topside Limit)	10 kHz - 1 GHz

MECHANICAL CHARACTERISTICS

Chassis Size	17.00" W x 22.42" D x 1.73" H (1U)
Case Material	Aluminum
Weight	33 lbs.

AC Input Connectors

AC Input Connector CB2-20-4PHA34-FM

DC Output Connectors

DC Output Connector CB2-20-19SXA34-FM

I/O Ports

Configuration I/O Port	HD DB15 Male
User I/O Port	HD DB15 Female
Ethernet Port	Amphenol RJF22N00, Code B

Cooling Exhaust Fans

Sound Pressure Level (SPL)	64 dB(A)
Air Flow	0.92(m ³ /min) 32.5 CFM

Two fans in system; above specs are for each fan separately.

Specifications subject to change without notice.

High Density DB15 Female (15 Pin Connector)

Signal	PIN	Function
TX	2	RS232 DCE Device Transmit
RX	3	RS232 DCE Device Receive
GND	4, 5	Ground reference for all digital inputs and outputs
BATTLE_MODE	6	TTL-Input*, pull "low" to engage Battle Mode to disable internal over temperature protection, has internal pull-up to +5 V
ACIN_GOOD	7	Open collector* output where "low" indicates AC Input voltage is within range
+5 V	8	Vout with minimal current drive usable as a pull-up voltage for open collector output signals. Load must be < 35 mA
REMOTE_START	12	Drive this line to +5 V with ≥ 5 mA to enable MPPS output
SHUTDOWN	13	Drive this line to +5 V with ≥ 5 mA to disable MPPS output
OUT_OK	14	Open collector* output where "low" indicates DC Output voltage is within range
OVER_TEMP	15	Open collector* output where "low" indicates that the MPPS is at or above its maximum temperature

*With an internal 50 k Pull-up Resistor to 5 V and ESD Protection Diodes



Safety & Qualifications (Pending)

EN 62368-1



Block Diagram

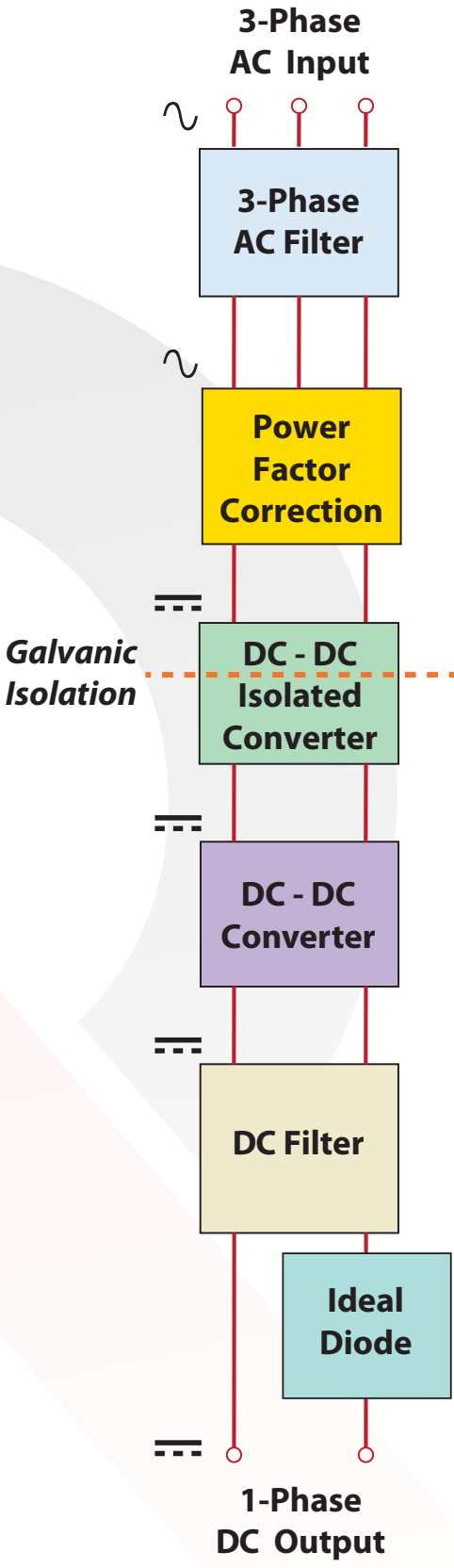



MPPS MILITARY FIELD-GRADE

MPPS-4000-270

Mechanical Features

MPPS-4000-270-1U UNIT Front



MPPS-4000-270-1U UNIT Rear

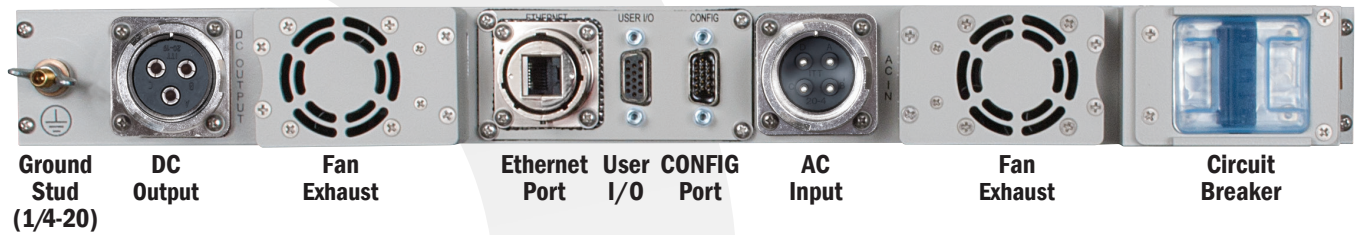



Mechanical Diagram 1U

MPPS MILITARY FIELD-GRADE

MPPS-4000-270

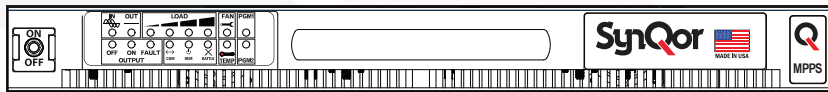
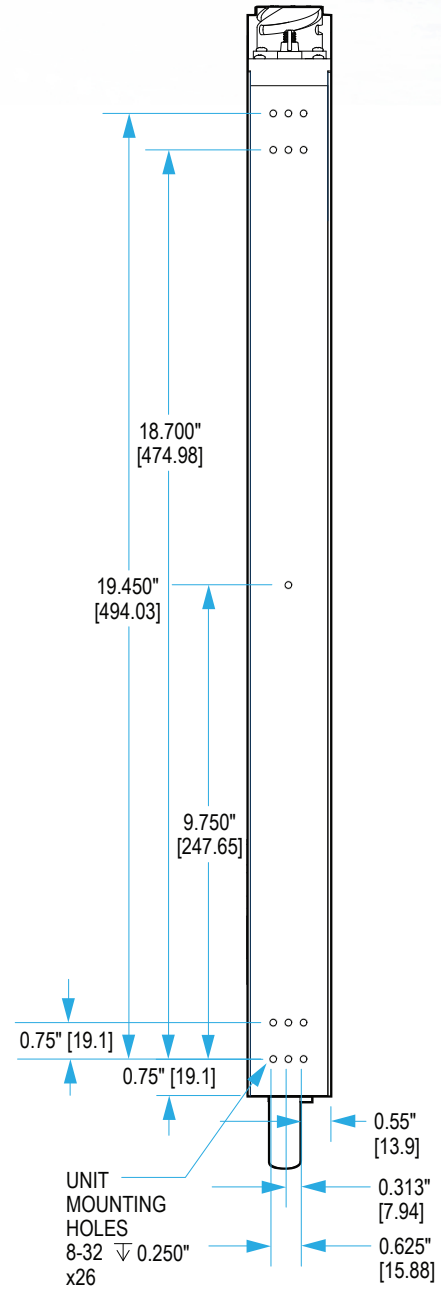
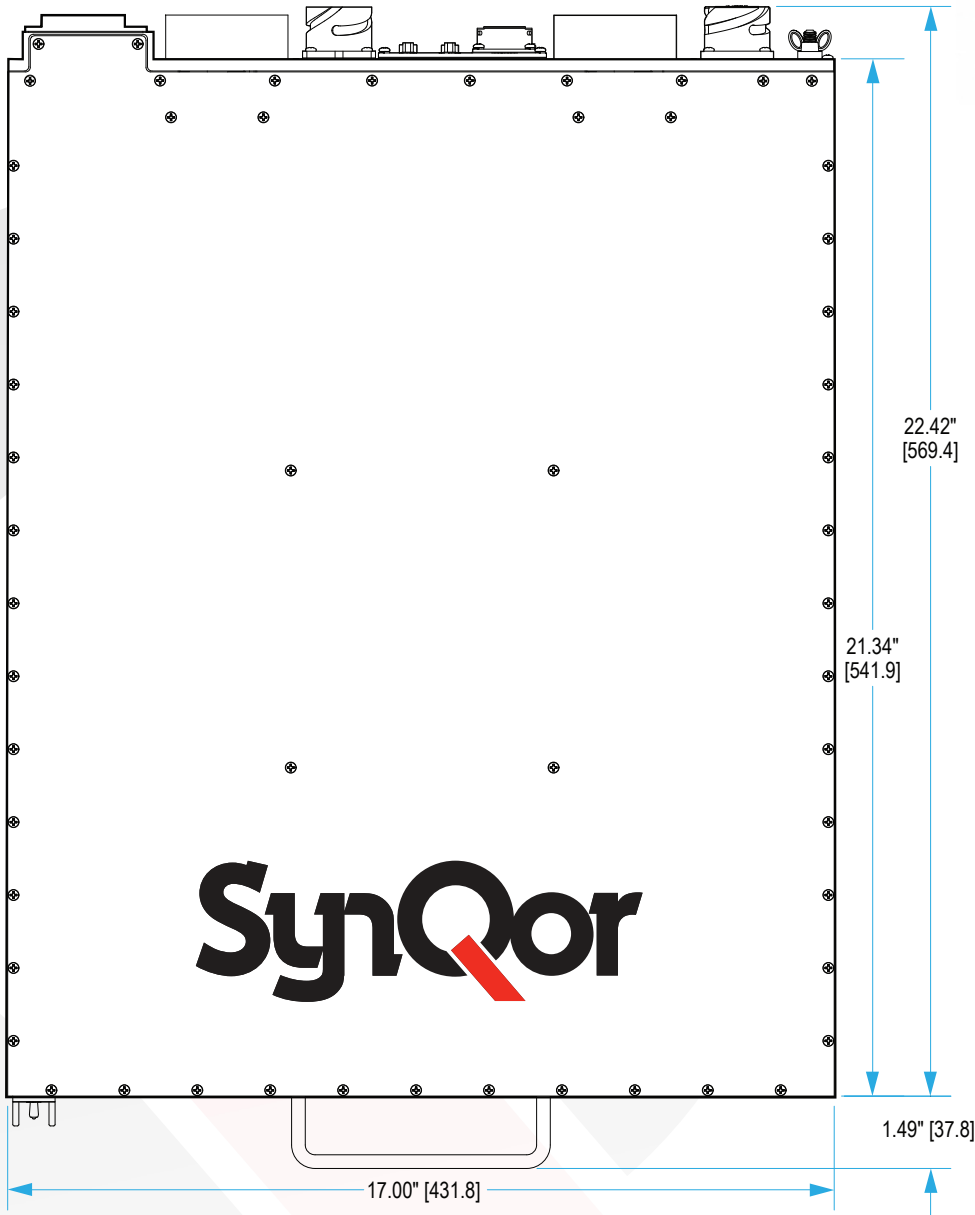

Note:

- 1) ALL DIMENSIONS IN INCHES [mm]
- TOLERANCES: X.XXIN +/- 0.02 [0.5]
- X.XXXIN +/- 0.010 [0.25]



Accessory Options

Rail Kits	
Slide Rail Kit ²	SYN-9002
Fixed Bracket Kit ³	SYN-9031
Power Cables (10' long)	
AC Input (Hardwire)	SYN-9118
DC Output (Hardwire)	SYN-9630
Rackmount Transit Cases	
Transit Case, 3U, Gray, with Casters ³	SYN-9410
Transit Case, 3U, Gray, No Casters ³	SYN-9412
Fan Replacement Kit	
Counter-Rotating Replaceable Fan Modules (Pack of 2)	SYN-9452

Notes:

- 1: Other Options also available, check the website or contact power@synqor.com for further information.
- 2: Slide Rail Kit (SYN-9002) is not recommended for transit and ruggedized use.
- 3: Fixed Bracket Kit (SYN-9031) with Transit Case (SYN-9410 or SYN-9412) is required for transit and ruggedized use (qualified to pass MIL-STD-810G Loose Cargo and Transit Drop requirements).

User Communications (I/O) Cables	
HD DB15M to DB9F (RS232, 10')	SYN-9301
HD DB15M to DB15M (RS232 and Digital I/O, 10')	SYN-9305
Mil-Circular to RJ45 (Ethernet, 10')	SYN-9321
Configuration Cables	
HD DB15F to DB15F (2 Units Parallel, 3')	SYN-9341
HD DB15F to DB15F (3 Units Parallel, 6')	SYN-9343
HD DB15F to DB15F (4 Units Parallel 9')	SYN-9344
HD DB15F to DB15F (5 Units Parallel 12')	SYN-9345



Optional
Rackmount Transit Case



Base Models			
Model Number	Power	Height (W x D x H)	Weight
MPPS-4000-1U-	4000 W	1U (17.00" x 22.42" x 1.73")	33 lbs.

Base Models	Options					
	Line to Line Input Voltage	Number of Input Phases	Input Freq Range	Output Voltage	Output Config	Additional Options
MPPS-4000-1U-	4	T	L	270	S	-E00

Options		
Line to Line Input Voltage	4	360-528 V
Number of Input Phases	T	3-Phase
Input Freq Range	L	47-65 Hz
270	270	Nominal Output Voltage
Output Config	S	DC Programmable, 25 - 400 Vdc 0.2 - 25 A
Additional Options	-E00	Ethernet/SNMP with Config Loading

Example:
MPPS-4000-1U-4TL270S-E00

Contact SynQor for further information and to order:
Phone: 978-849-0600 **Toll Free:** 888-567-9596 **Fax:** 978-849-0602
E-mail: power@synqor.com **Web:** www.synqor.com
Address: 155 Swanson Road, Boxborough, MA 01719 USA

WARRANTY
 SynQor offers a one (1) year limited warranty. Complete warranty information is listed on our website or is available upon request from SynQor.

PATENTS
 SynQor holds numerous U.S. patents, one or more of which apply to most of its power conversion products. Any that apply to the product(s) listed in this document are identified by markings on the product(s) or on internal components of the product(s) in accordance with U.S. patent laws. SynQor's patents include the following:
 7,050,309 7,765,687 7,787,261
 8,149,597 8,644,027